



# Autonomous Passenger Retrieval System for Automobiles

**Ms. Sihle Wilson, M.S. Software Engineering Student**

Ronald Benson, M.S. Software Engineering Student

Tyshun Jones, B.Sc. CIS Major

Professor: Dr. Jason Black

Florida A&M University

Sunday, 11<sup>th</sup> July 2010





## Agenda

- Project Overview
- Sensors
- Communication
  - Internal
  - External
- Vehicle Actuation
- Decision Making
  - Neural Network Component
  - Fuzzy Logic Component
- Next Steps and Future Work
- References
- Questions





## Project Overview

- Project Objective
  - To create an AI plug-in for vehicles that will allow them to independently retrieve objects from a location no more than 1 mile away that can intelligently avoid collisions
- Basic Functionalities of Vehicle
  - Remote start
  - Update car settings like radio, AC seat positioning, etc using cell phone
  - Run Diagnostics on Vehicle via Phone interface
  - **Intelligent Collision Avoidance System**





## Sensors and Navigational System

- Object Detection Sensors
  - Stereo Camera
  - Ultrasonic Sensors
  - Laser Range Finder
- Navigation Sensors
  - RFID
  - GPS Device



Point Grey Bumblebee2 Stereo Vision Camera  
(<http://www.ptgrey.com>)



Sick LMS 200 Laser Range Finder





## Communication

- Internal Communication (in Vehicle)
  - Among elements within the vehicle
    - Sensors and microcontroller
    - Microcontroller and Actuators to control motion
- External Communication
  - Between vehicle and user's mobile device
  - Between mobile device and web server

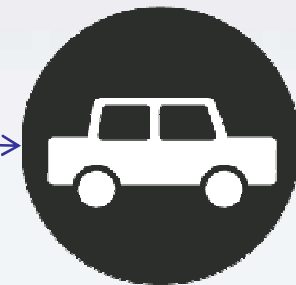



## Communication

- Mobile Device
  - Current cellular phones have built in access to the internet
  - Many current consumer devices also have WIFI capabilities
- Vehicle
  - 3G and 4G networks
    - Wireless network provider would be the most reliable connection to vehicle
  - DSRC and WIFI
    - Both are alternatives to dedicated 3G and 4G networks, but would not be available in all areas





# Communication

- Mobile Device
  - GUI Interface for Mobile Devices

Home X









**Welcome to the Car Retrieval App**







**Menu**

- Pick me Up
- Car Features
- User Profile

**Car Features**

- Air Conditioning  On/Off
- Map view 
- Car Diagnostics 
- Sun Roof  Open
-  Close
- Window  Open
-  Close

## Car Diagnostics

-  Battery
-  Oil Level
-  Engine check
-  Power Steering level
-  Gas Level
-  Transmission Fluid level
-  Lights Check
- Webserver





# Vehicle Actuation

- X by Wire Systems
  - Replace mechanical systems for steering, brake, and throttle in automobiles with a system of sensors and electronic control units
  - Prior research has shown that manipulation of these systems can be used to control automobiles.

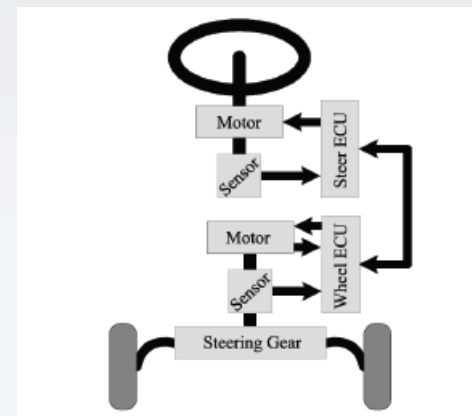





# Vehicle Actuation

- In-Vehicle Networks
  - Coordinate communication between electronic control units used within vehicles.
    - Controller Area Network currently most used; newer protocol FlexRay more powerful
  - Controller Area Network used by certain teams in DARPA Urban Challenge to interface with by-wire systems.

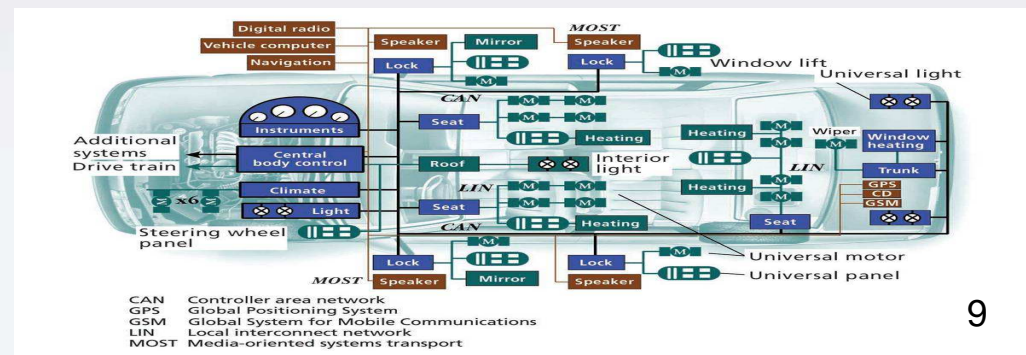



# Decision Making

- **Neural Networks**

- the study in which computational methods have been derived to mimic the brain through the use of highly interconnected, processing elements which give them learning capabilities and enable them to recognize and understand, subtle or complex patterns
- adaptive system that allows the network to change its structure based on data transmitted through it during its learning phase

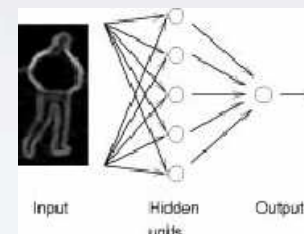

Architecture of the Neural Network [Zhao et.al, 2000]



## Decision Making

- Neural Networks

- Pomerleau et al. at Carnegie Mellon University showed that the technique of training multiple networks to accomplish individual, independent tasks can be used in autonomous vehicle control.
- Pomerleau et al were also able to train their networks in under 5 minutes to drive in various situations including collision avoidance.
- They were also able to “train” their vehicle, ALVINN, using a developed training scheme called training “on the fly” to quickly teach individual modules how to imitate humans driving reactions





## Decision Making

- Fuzzy Logic

- Technique created by Lotfi Zadeh from a University of California at Berkley
- is an artificial intelligence technique that recognizes that statements are not only evaluated to be true or false but can also be varying degrees of both values
- Naranjo and the team of researchers from Instituto de Automatica Industrial proved that using embedded fuzzy-logic-based control system can be used to control the speed and steering of a vehicle
- They were able to model their guidance and adaptive cruise control (ACC) and overtaking systems using fuzzy variables and rules.





## Decision Making

- Application of Neural Network
  - Train vehicle difference between different positions humans and animals can take
- Application of Fuzzy Logic
  - In the event that data is not complete from sensors, Fuzzy Logic will be used to help guide vehicle what to do





## Next Steps and Future Work

- Finalize Neural Network
- Acquire parts and implement in hardware
- Create algorithm that instructs vehicle appropriate responses to perceived data input
- Create another Neural Network to learn user's drive patterns e.g. to and from work





## References

- *Neural-Network-Based Fuzzy Logic Control and Decision System.* **Lin, C.T and Lee, C.S.G.** 12, 1991, IEEE Transactions on Computer, Vol. 40, pp. 1320-1336.
- *Combining Artificial Neural Networks and Symbolic Processing for Autonomous Robot Guidance.* **Pomerleau, D. A, Gowdy, J. and Thorpe, C. E.** 1991, Engineering Application Artificial Intelligence, Vol. 4, pp. 279-285
- *Using Fuzzy Logic in Automated Vehicle Control.* **Naranjo, J.E., et al.** 2007. pp. 36-45.
- *Stereo- and Neural Network-Based Pedestrian Detection.* **Zhao, Liang and Thorpe, Charles E.** s.l. : IEEE TRANSACTIONS ON INTELLIGENT TRANSPORTATION SYSTEMS, 2000. Vol. 1





## Questions



Your Car is Outside

OK

# Questions

# ?

